

A	B	C		D
1	KT1-162-01	430	480	2/4
2	KT1-252-01	1300	650	1/4
3	KT1-338	850	348	3/4
4	KT1-413	850	80	3/4
5	KT1-1588	540	80	4/4

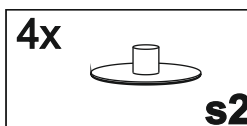

**1** §2

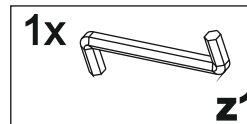
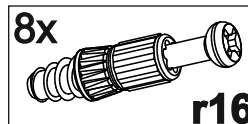
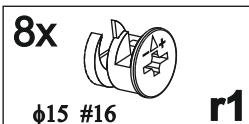
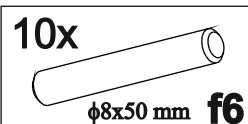
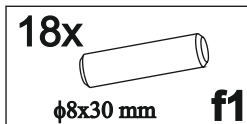
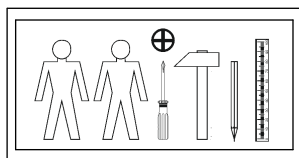
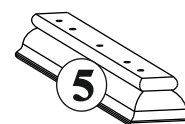
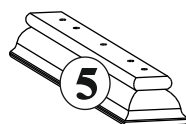
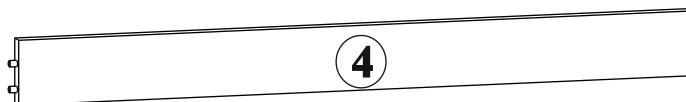
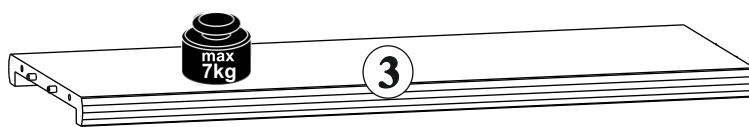
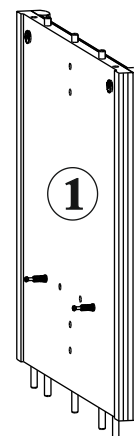
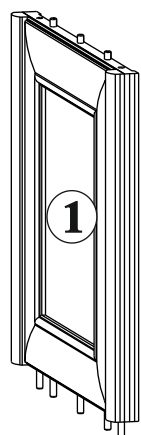
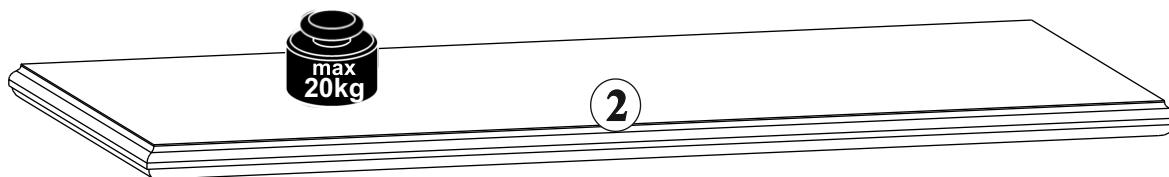
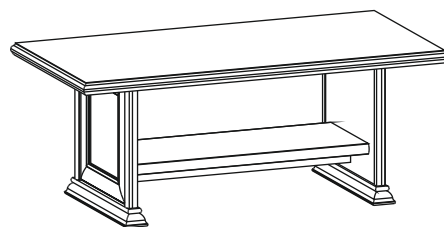
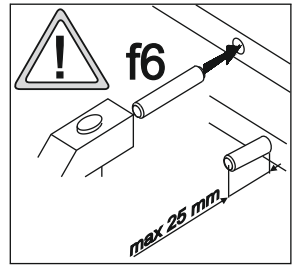
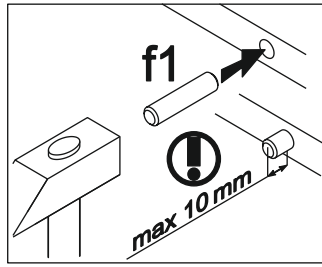
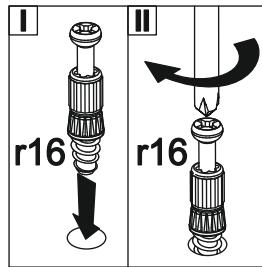
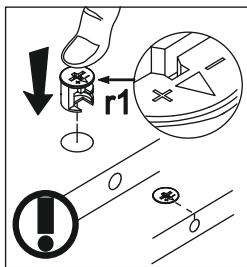
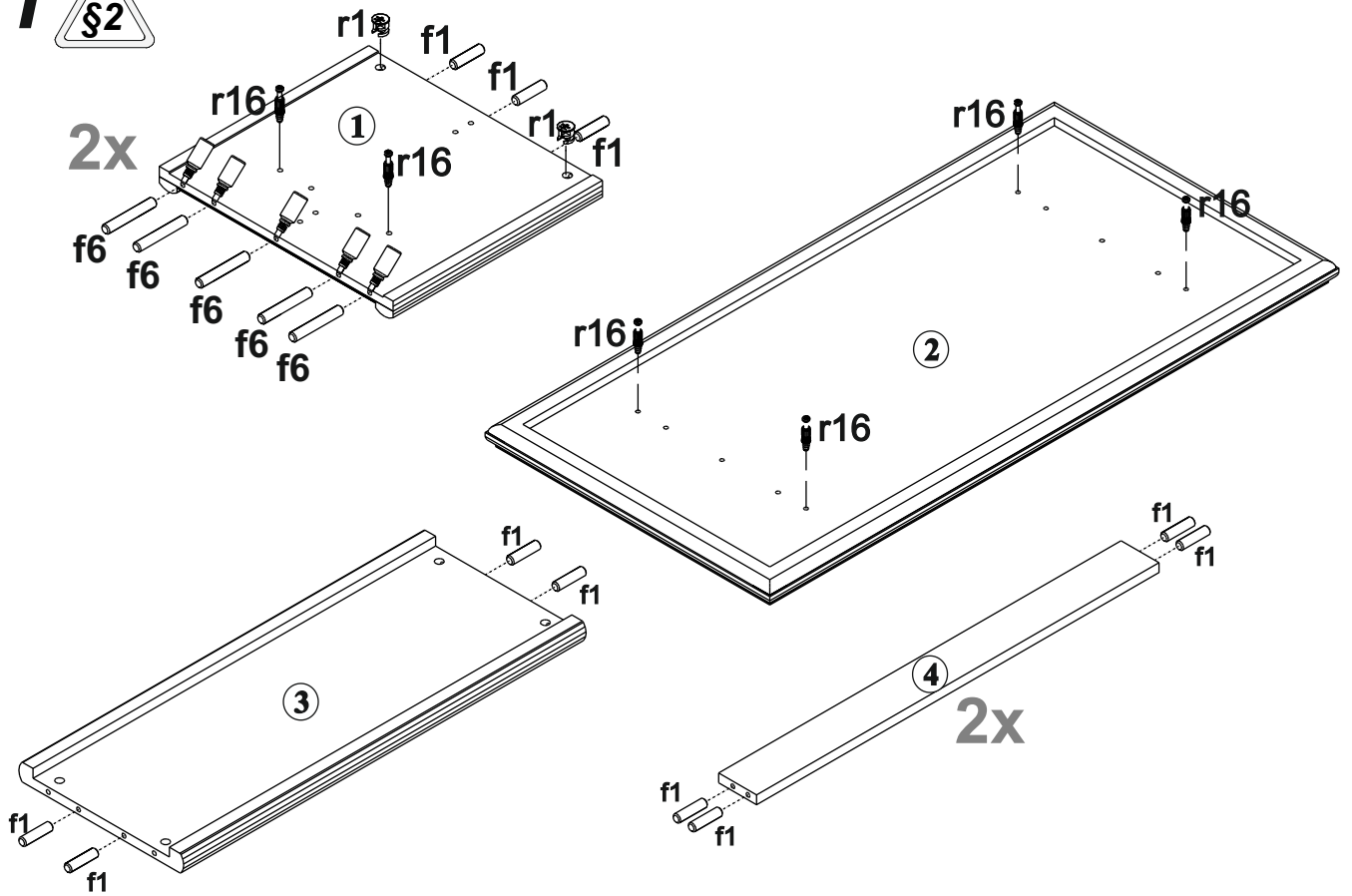

**2** §6

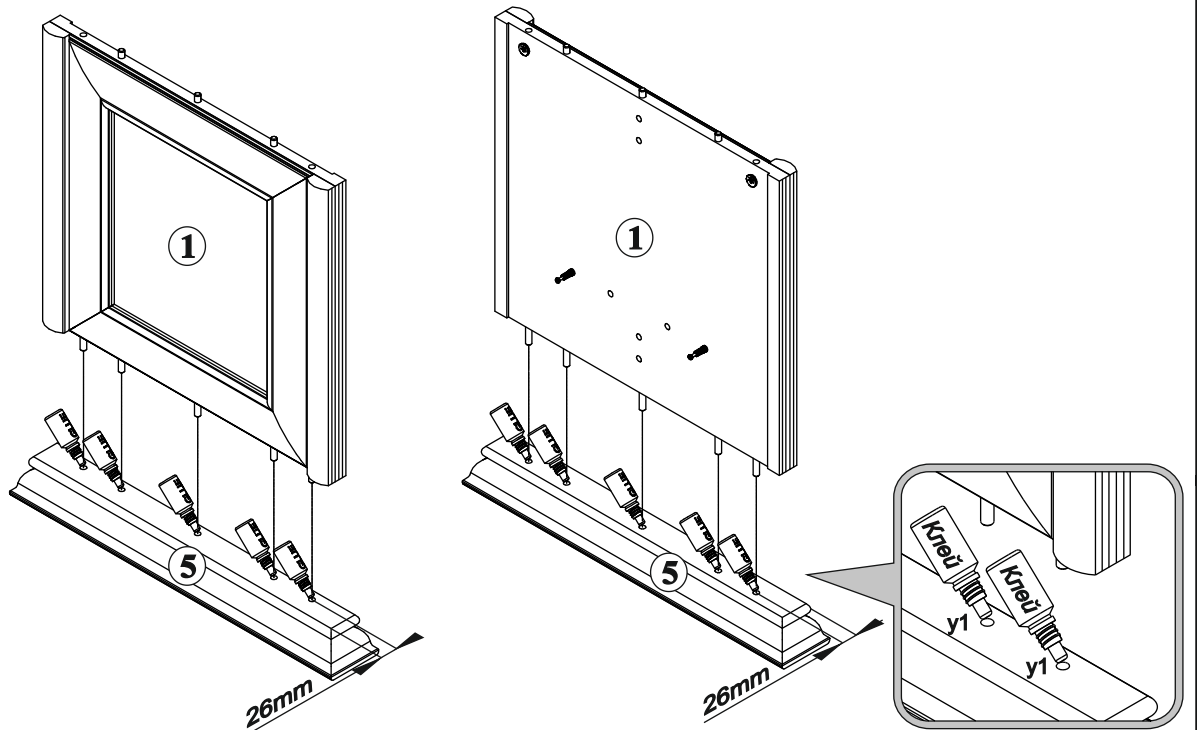

# 3

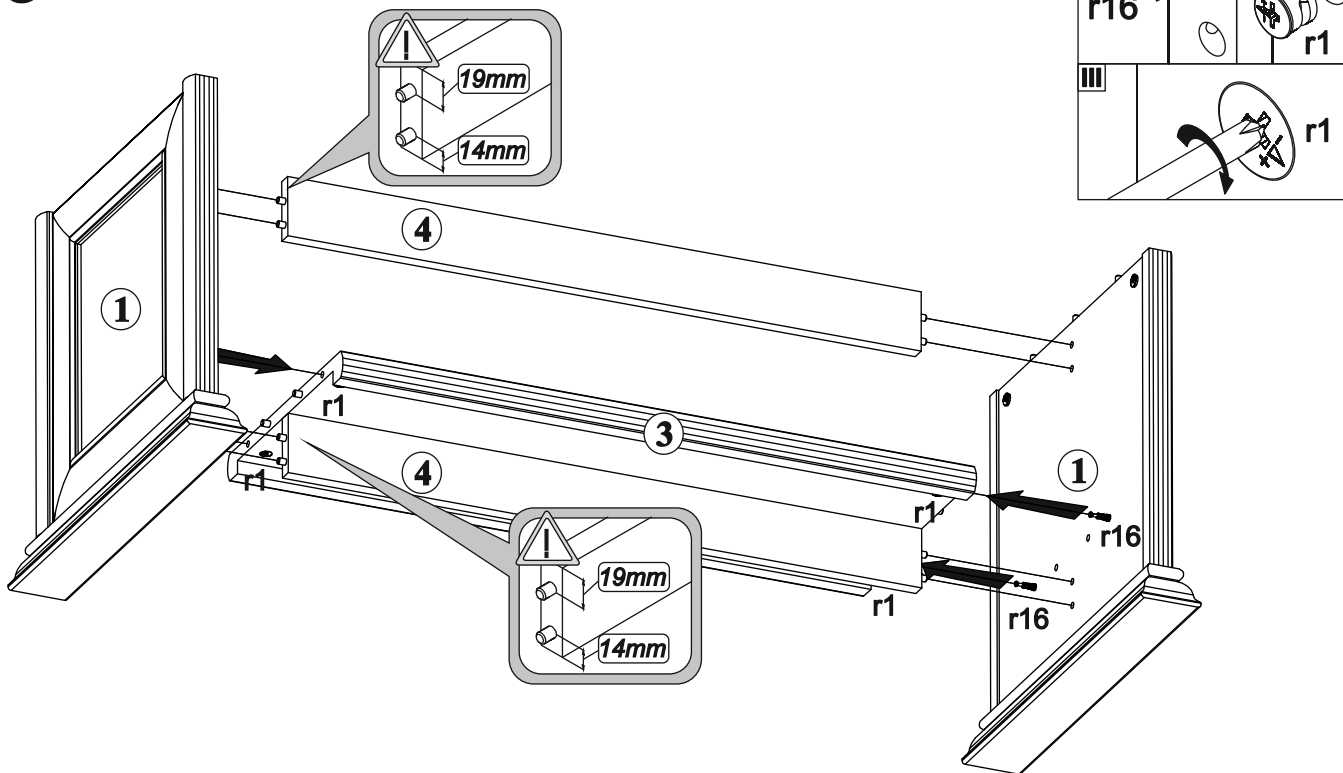

# 4

