

https://www.szynaka.pl/pl/instrukcje_montazu

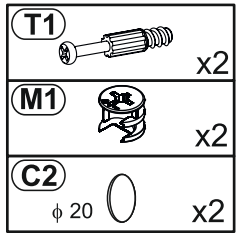

| Nr | | | | pcs | |
|----|------|-----|----|-----|---|
| 1 | 748 | 700 | 50 | 2 | 2 |
| 2 | 1570 | 400 | 16 | 1 | 1 |
| 3 | 1700 | 730 | 22 | 1 | 1 |

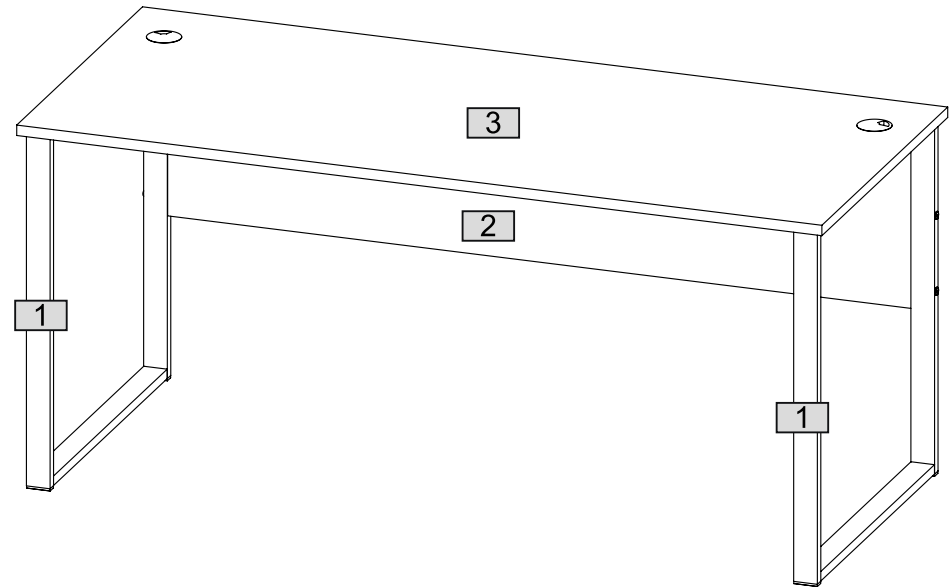
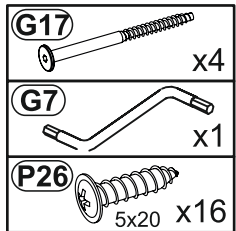
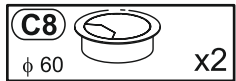

1

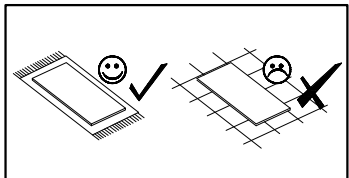
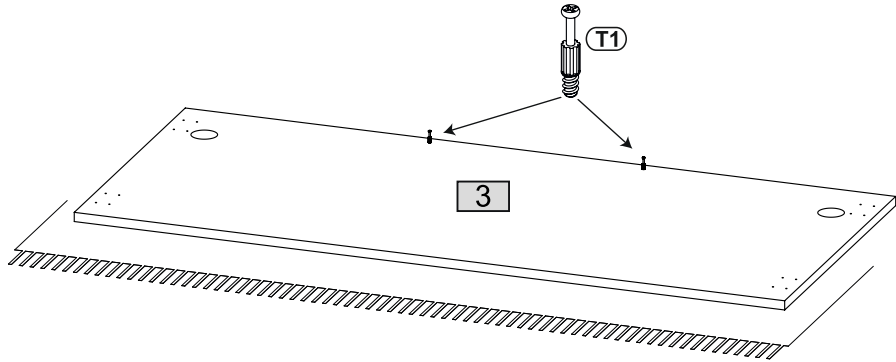
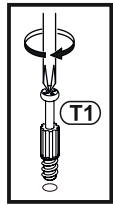
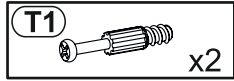

2

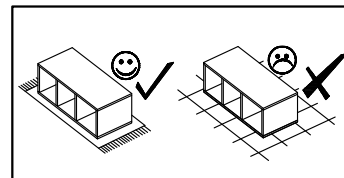
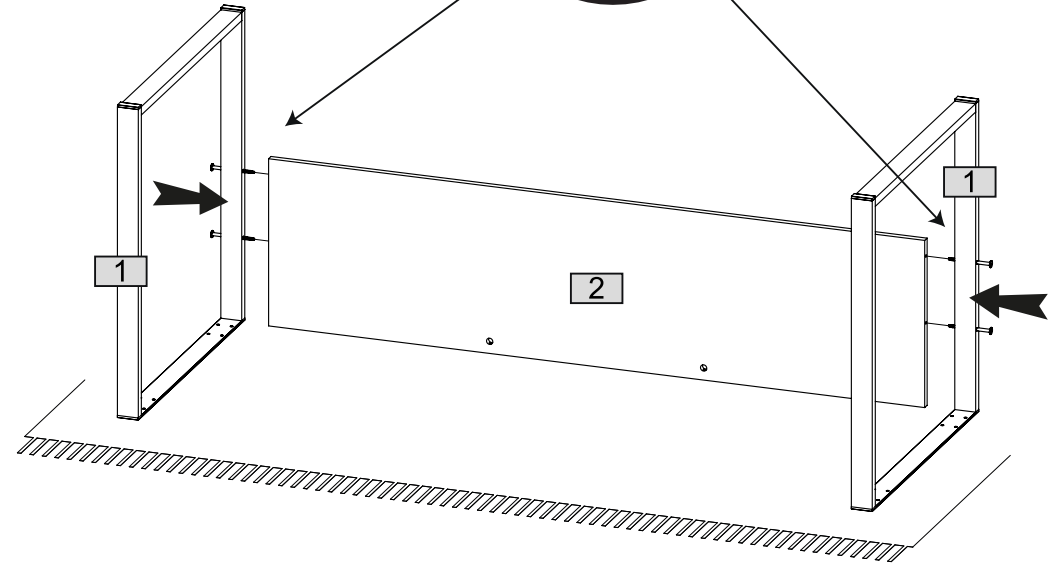
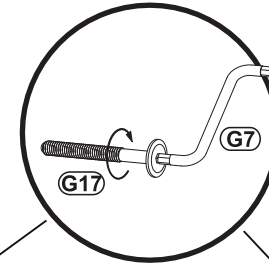
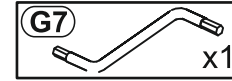
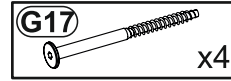

3

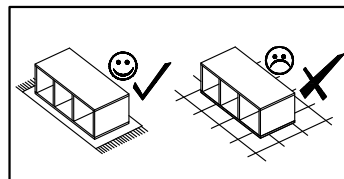
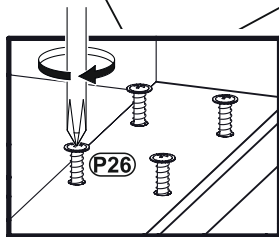
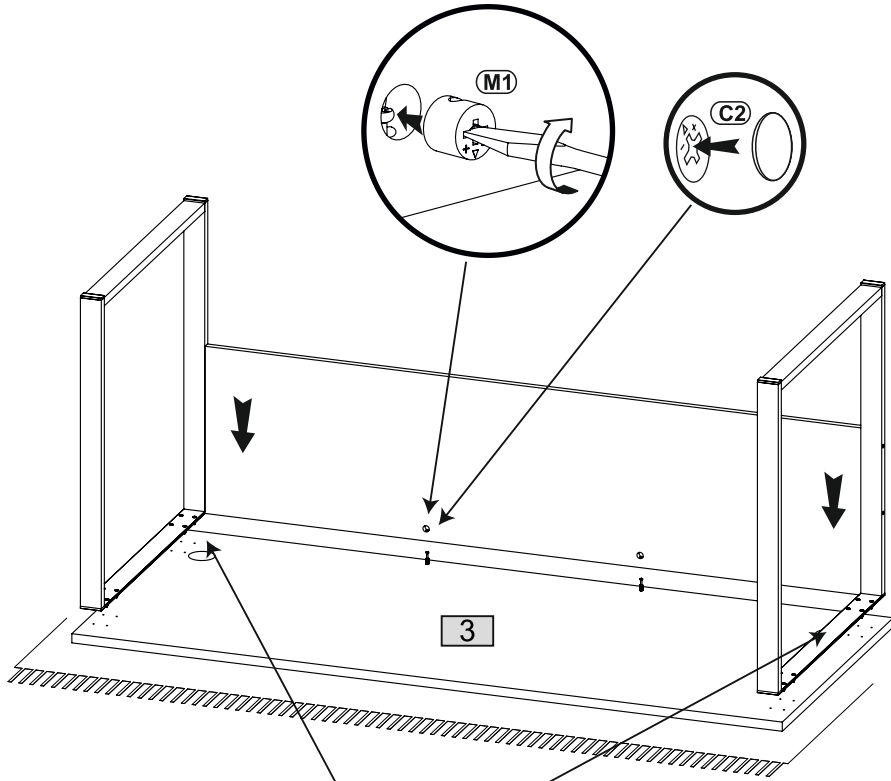
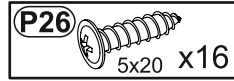
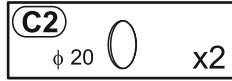

4

